

アルミC型ジョイナー

■アルミC型ジョイナー 2.73m (B2アルマイト仕上げ)

2.5CS

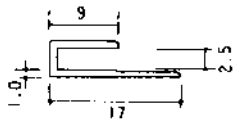

3.5CS

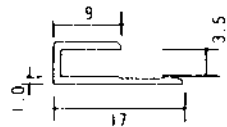

4.5CS

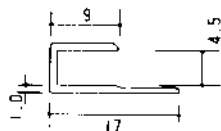

5.5CS

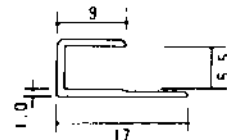

6.5CS

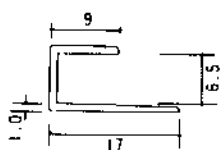

7.5CS

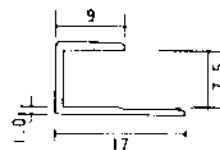

8.5CS

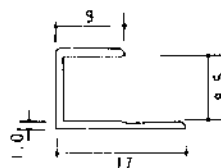

10CS

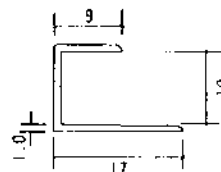

10.5CS

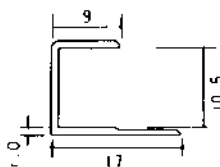

13CS

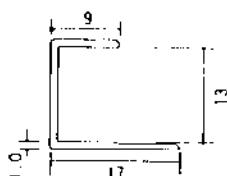

■断熱材用アルミジョイナー 3m (B2アルマイト仕上げ)

アルミKK25

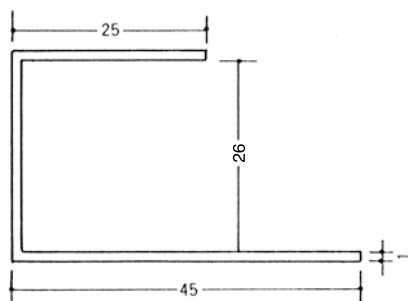

アルミKK50

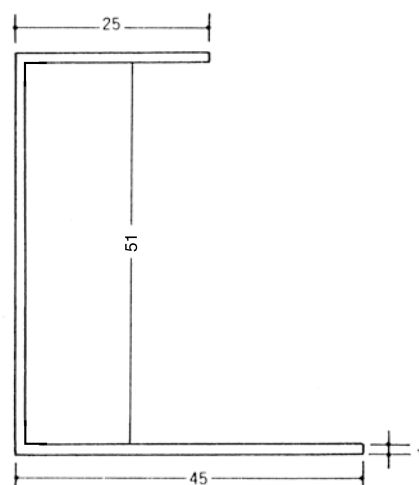

アルミH型ジョイナー

■アルミH型ジョイナー 2.73m (B2アルマイト仕上げ)

2.5HS

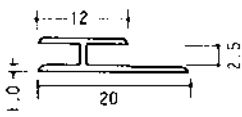

3.5HS

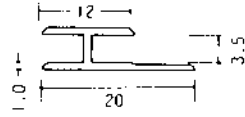

4.5HS

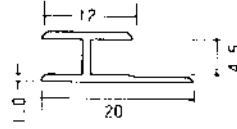

5.5HS

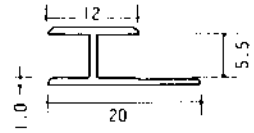

6.5HS

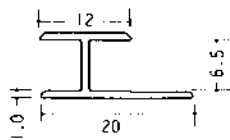

7.5HS

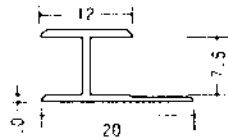

8.5HS

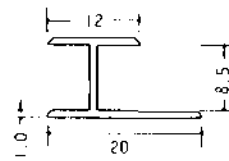

10HS

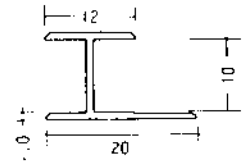

10.5HS

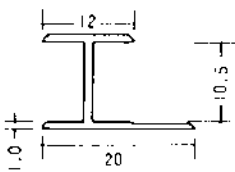

13HS

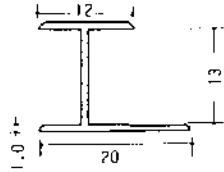

■断熱材用アルミジョイナー 2.73m (B2アルマイト仕上げ)

アルミ25KHS

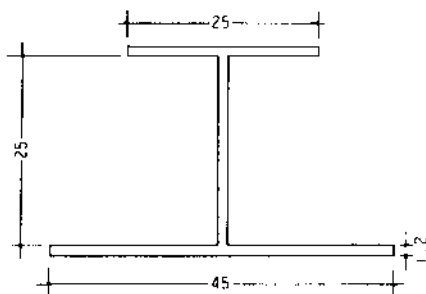

アルミ50KHS

